

RGBV RMBV

TRIPPING RELAY, LATCHING
HIGH SPEED, 4 - 8 - 12 CONTACTS

APPLICATIONS



Shipbuilding



Petroleum industry



Heavy industry



Power generation



Power distribution

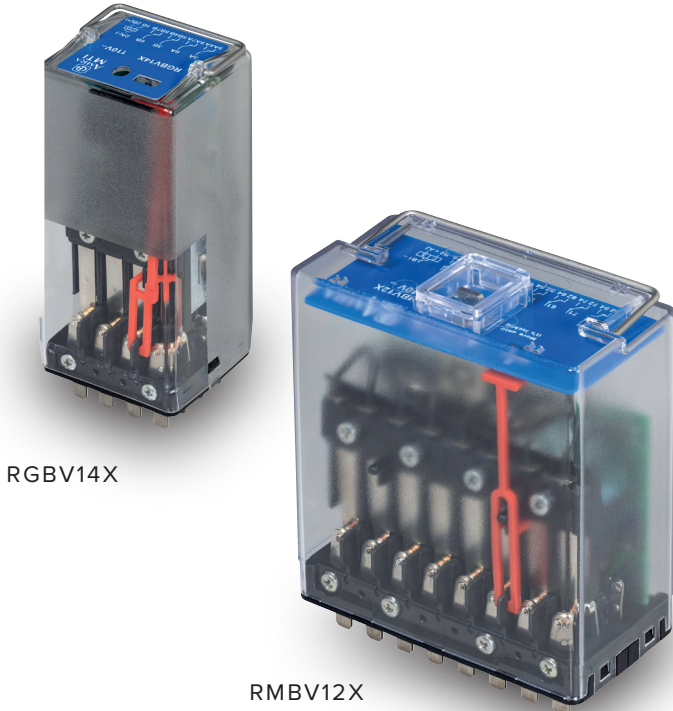

RGBV14X

RMBV12X

OVERVIEW

- High speed operation, **tripping applications**
- High burden configuration, providing **immunity to capacitance discharges**
- Plug-in latching, lockout, trip relay
- High performance, compact dimensions, light weight
- Solid and rugged construction for intensive duty
- Self-cleaning knurled c/o contacts
- Wide contact gap for a **very high breaking capacity**, electrical life expectancy and insulation
- **Magnetic arc blow-out** as standard
- Wide range of sockets

DESCRIPTION

RGBV and RMBV relays are highly reliable, high performance products, suitable for applications in very harsh and disturbed environments, as per protection, command and control systems for HV electrical substations or power stations.

The range includes relays with 4, 8 and 12 contacts.

These lockout (latching) relays have 2 stable positions; contacts are able to hold their position after energizing the “SET” coil or the “RESET” coil.

All models are equipped with an automatic coil cut-off system, designed to have no power consumption once the operation is completed.

A MANUAL LEVER allows the relays to be operated manually.

These relays are designed for **circuit breaker tripping applications**, where **fast-acting** contact is essential in order to **minimize the total trip time** and avoid, in case of emergency situation, damages to the **transmission station** equipments.

The **high speed** in operation, the high breaking capacity and the **ability to switch also very low load** (few mA) allow their use in demanding applications such as:

- Duplication of HV/MV protection’s outputs
- Direct acting to HV/MV primary equipment
- Trip alarms transmission

Knurled contacts surface ensures an excellent self-cleaning effect, a lower ohmic resistance thanks to the various points of electrical contact, improving also the electrical life of the component.

The contacts are designed to obtain **remarkable performances both for high, inductive loads or very low loads**. Contact is able to switch from 10mA – 10V at relay new.

Magnetic arc blow-out contributes to increase the breaking capacity: the relay can manage heavy duty loads with intensive switching frequency.

“High Burden” (HB) option provide **immunity to capacitance currents & power discharge** to the coil, in order to avoid relay operations in case of, for example, transients coming from extensive wiring.

STANDARD COMPLIANCE

EN 61810-1	EN 60695-2-10
EN 61810-2	EN 60529
EN 61810-7	EN 61000



MODELS	NUMBER OF CONTACTS	HIGH BURDEN ⁽¹⁾ configuration	MANUAL OPERATION	OPERATING TIME Pick-up (ms)
RGBV14X	4	–	Option	≤ 10
RGBV16X	4	✓	Option	
RMBV12X	8	–	✓	≤ 10
RMBV14X	8	✓	✓	
RMBV15	12	–	Option	≤ 10
RMBV16	12	✓	Option	

(1) **HIGH BURDEN Configuration:** for the operating and the specifications refer to the paragraph “**COIL DATA - HIGH BURDEN Configuration**” (see the table below).



FOR PRODUCT CODE CONFIGURATION, SEE THE “ORDERING SCHEME” TABLE



COIL DATA - STANDARD Configuration	4 C/O	8 C/O	12 C/O
Nominal voltages at Un	DC: 24-48-110-125-220V / AC: 230V		
AVG consumption at Un (only while switching)	< 22 W	< 35 W	≤ 75 W
Operating range	DC: 80 ÷ 110% Un / AC: 80 ÷ 110%		
Type of duty	Continuous		



COIL DATA - HIGH BURDEN Configuration	4 C/O	8 C/O	8 C/O
Nominal voltages at Un	DC: 24 - 48 - 110 - 125 - 220V		
AVG consumption at Un (only while switching)	< 22 W	< 35 W	< 75 W
Peak consumption	24 - 48Vdc: 300 W 110 - 125 - 220Vdc: 300 W		
Immunity to capacitive discharge	10 μF @ 120% Un across the coil		
Operating range	DC: 80 ÷ 110% Un		
Type of duty	Continuous		

HIGH BURDEN CONFIGURATION provides higher security in plant control system, avoiding unwanted relay operation due to capacitive discharge currents, for example in case of an earth fault in long DC cables. A typical application is where the initiating contact may be remote from tripping relay.

HIGH BURDEN Tripping Relays is designed to withstand a “10μF capacitor discharge test”.

- Relay will not operate when a 10 μF capacitor, charged @ 120% Un, is applied across the coil.

While switching, high energy is required. After operation, high coil burden is reduced to a very low value, ensuring energy saving and avoiding overload on power supply circuit or station battery.

An electronic circuit acts as coil voltage’ regulator and controls the duration of burden.

CONTACT DATA

4 C/O, 8 C/O, 12 C/O



Current	Nominal ⁽¹⁾ Maximum pulse ⁽²⁾	10A 20A for 1min 40A for 1s 150A for 10ms	
Example of electrical life ⁽³⁾		1A - 110Vdc - L/R 0ms - 350,000 operations 0.5A - 220Vdc - L/R 0ms - 300,000 operations	
Making capacity		30A (for 200ms) - 110Vdc - L/R 0ms: 2,000 operations	
Minimum load ⁽⁴⁾	Standard contacts Gold-plated contact ⁽⁵⁾	200mW (10V, 10mA) 50mW (5V, 5mA)	
Maximum breaking voltage		250Vdc / 350Vac	
Contact material		AgCdO	
Operating time at Un (ms) ⁽⁶⁾	Pick-up ms Drop-out ms	Vdc: ≤ 10 Vdc: ≤ 10	Vac: ≤ 10 Vac: ≤ 10

(1) On all contacts simultaneously, reduction of 30%.

(2) The maximum pulse currents are those currents that can be handled, for a specified time, by the contact. They do not refer to make or break currents.

(3) For other examples, see electrical life expectancy curves.

(4) Values referred to a new product, measured in laboratory. The ability to maintain this performance over the time depends on the environmental conditions and the contact' frequency use. The use of gold plated contacts is recommended in the case of very low loads. For a correct contact use, refer to the chapter "Installation, operation and maintenance".

(5) A gold-plated contact, if subjected to high loads, degrades superficially. In this case, the characteristics of the standard contact must be considered. This does not affect the operation of the relay.

(6) Unless specified otherwise, the operating times are expressed excluding bounces.

Only for Vac power supply: actual value may increase of max 5ms (pick-up, worst case) or 10ms (drop-out, worst case). It depends on the sinusoid front (rising or falling) while energizing or de-energizing.

INSULATION



Insulation resistance (at 500Vdc) between electrically independent circuits and between these circuits and ground	> 1,000 MΩ
Dielectric withstanding voltage at industrial frequency between electrically independent circuits and ground between adjacent contacts	2 kV (1 min) - 2.2 kV (1 s) 2 kV (1 min) - 2.2 kV (1 s)
Impulse withstand voltage (1.2/50μs - 0.5J) between electrically independent circuits and between these circuits and ground between open contact parts	5 kV 3 kV

MECHANICAL SPECIFICATIONS

4 C/O

8 C/O

12 C/O



Mechanical life expectancy	10x10 ⁶ operations		
Maximum switching rate Mechanical	3,600 operations / h		
Protection rating (with relay mounted)	IP40		
Dimensions (mm) ⁽¹⁾	45x50x86	45x90x100	58x188x84
Weight (g)	270	400	810

(1) Output terminals excluded.

ENVIRONMENTAL CHARACTERISTICS



Operating temperature	-25 ÷ +70°C
Storage and shipping temperature	-40 ÷ +85°C
Relative humidity	Standard: 75% RH - Tropicalized: 95% RH
Fire behaviour	V0



STANDARDS AND REFERENCE VALUES

EN 61810-1, EN 61810-2, EN 61810-7	Electromechanical elementary relays
EN 60695-2-10	Fire behaviour
EN 60529	Degree of protection provided by enclosures
EN 61000	Electromagnetic compatibility



CONFIGURATIONS - OPTIONS

TROPICALIZATION	Surface treatment of the coil with protective coating for use with RH 95%.
GOLD PLATING	Surface treatment of the contacts, with gold-cobalt alloy $\geq 5\mu$ (since 2023, May). This treatment ensures long-term ability of the contact to conduct lower currents.
LEVER FOR MANUAL OPERATION	Allow to manual operating the relay
HIGH BURDEN (HB)	The HB "High Burden" Configuration provide immunity to capacitance discharge currents & power to the coil, in order to avoid relay operations, for example in case of transients coming from extensive wiring.



ORDERING SCHEME

PRODUCT CODE	CONFIGURATION A	CONFIGURATION B	TYPE OF POWER SUPPLY	NOMINAL VOLTAGE (V)	FINISH ⁽¹⁾
RGBV	1: Standard 4: Gold Plating	4X: 4 contacts 6X: 4 contacts with HB	C: Vdc A: Vac	Vdc 024 - 048 - 110 - 125 Vac 230 ⁽²⁾	T: Tropicalized coil M: Lever for manual operation
RMBV	1: Standard 4: Gold Plating	2X: 8 contacts 4X: 8 contacts with HB	C: Vdc A: Vac	Vdc 024 - 048 - 110 - 125 Vac 230 ⁽²⁾	T: Tropicalized coil (lever for manual operation always included)
RMBV	1: Standard 4: Gold Plating	5: 12 contacts 6: 12 contacts with HB	C: Vdc A: Vac	Vdc 024 - 048 - 110 - 125 Vac 230 ⁽²⁾	T: Tropicalized coil M: Lever for manual operation

(1) Optional value. Possible the multiple choice (Ex. TM)

(2) NOT AVAILABLE FOR HB Configuration

Example

RGBV	1	6X	C	024	
RGBV16X-C024= Relay with standard contacts, 4 C/O, High Burden configuration, 24Vdc coil					
RMBV	4	5	A	230	M
RMBV45-A230/M= Relay with gold plating, 12 C/O, 230Vac coil, lever for manual operation					

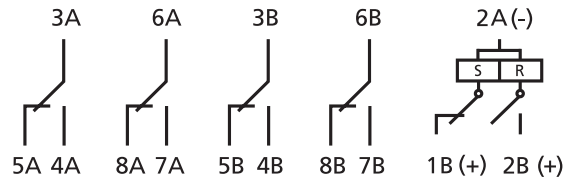

RGBV14X - RGBV16X

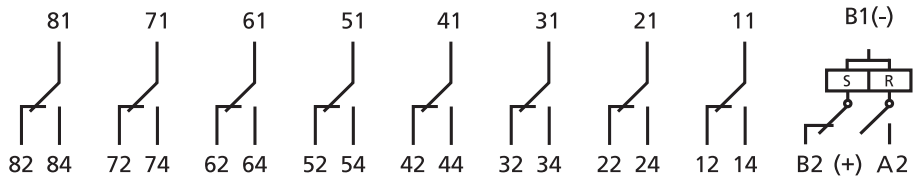

RMBV12X - RMBV14X

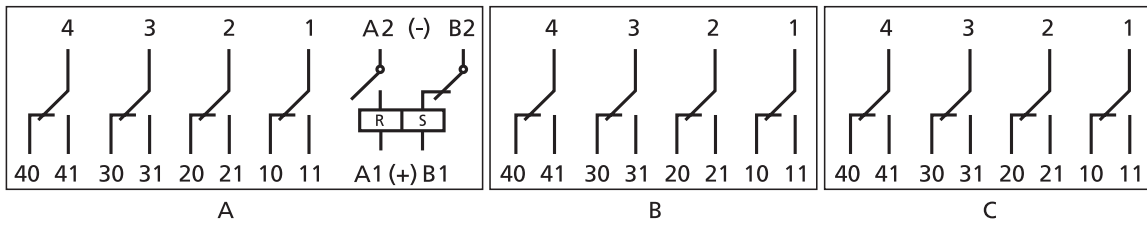

RMBV15 - RMBV16

NOTE:

Coils nomenclature change from 2024/05

S = SET (it was C)

R = RESET (it was S)

DIMENSIONS

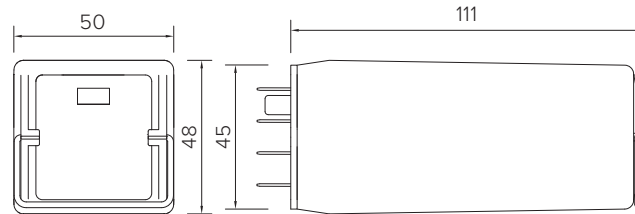

RGBV14X - RGBV16X

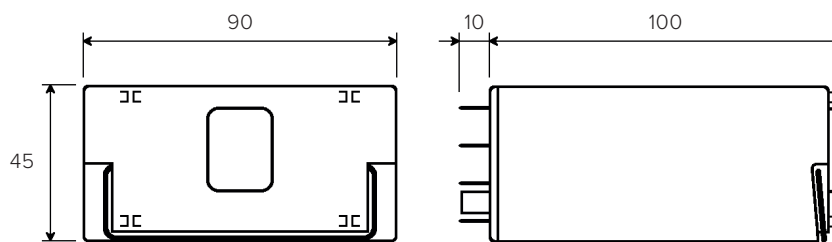

RMBV12X - RMBV14X

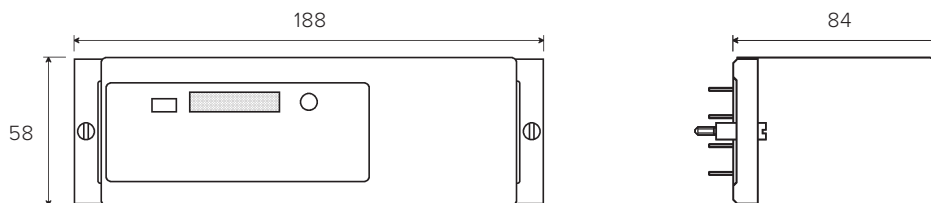

RMBV15 - RMBV16



ELECTRICAL LIFE EXPECTANCY

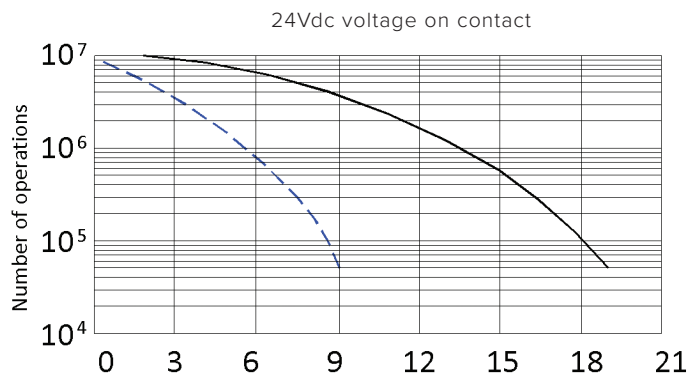

LEGEND

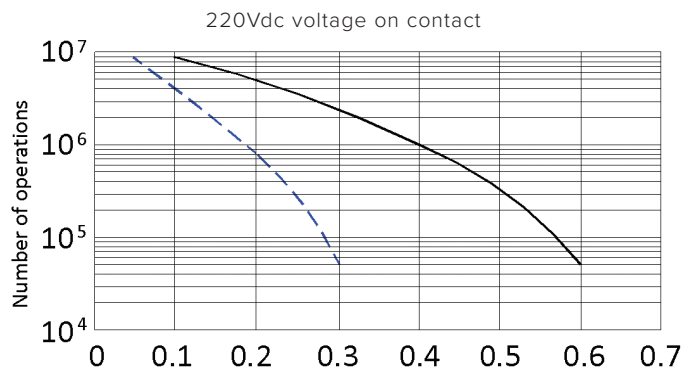
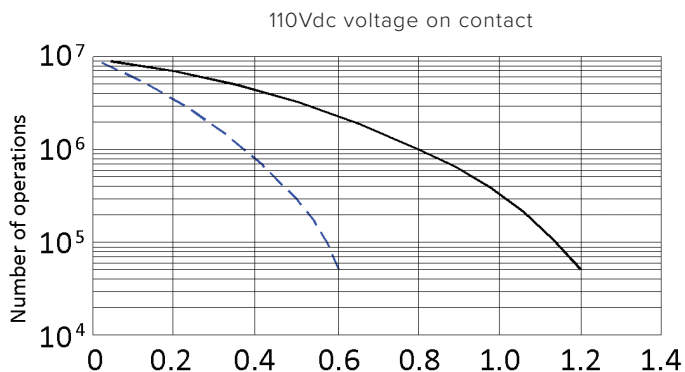
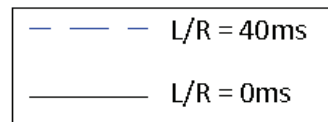

SOCKETS

SOCKETS		RGBV.x4X - RGBV.x6X	RMBVx2X - RMBVx4X	RMBVx5 - RMBVx6
Type of installation	Type of outputs	Model		
Wall or DIN H35 rail mounting	Screw	48BIP20-I DIN	96IP20-I DIN	PAVM481
	Spring clamp	PAIR160	PAIR320	-
Flush mounting	Screw	-	-	PRVM481
	Spring clamp	PRIR160	PRIR320	-
	Double faston (4.8 x 0.8 mm)	ADF2	ADF4	PRDM481



RETAINING CLIPS

RETAINING CLIPS	RGBV.x4X - RGBV.x6X	RMBVx2X - RMBVx4X	RMBVx5 - RMBVx6
Socket models	Model		
48BIP20-I DIN, 96IP20-I DIN	RGL48	RMC48 ⁽¹⁾	-
PAIR160, PAIR320			-
ADF2, ADF4			-
PAVM481, PRVM481, PRDM481	-	-	Fixing with integrated screws

(1) 2 pieces for each relay



INSTALLATION, OPERATION AND MAINTENANCE

Installation

Before installing the relay on a wired socket, disconnect the power supply.

The preferential mounting position is on the wall, with the relay positioned horizontally in the "reading orienting" of marking so that the label is readable in the correct sense.

Spacing: no relay spacing is required.

For a safe use, the retaining clip is recommended. 12 C/O relay is equipped by fixing screws.

For further details please read the paper document supplied with the relays and named "Instructions for installation of multi-pole relays".

Operation

Before use: if relay is not used, for example after long storage periods, contact resistance may increase due to a natural and slight oxidation or polluting deposits.

In order to restore the optimal conductivity and for standard contacts (**NOT gold plated**) it is recommended to switch several time a load of at least 110Vdc - 100mA or 24Vdc - 2A. The contacts will be "cleaned" thanks to the electric arc generated during the current interruption and the mechanical self-cleaning action.

The common contact rubs against the fixed poles (NO and NC contacts) both when opening and when closing, which ensures a self-cleaning action.

An increase in contacts' resistance, in most cases, does not represent a problem. Many factors contribute to the correct use of contact and consequently to the relay' long-term reliability:

- **Load:** the current switching generates an electric arc with cleaning effects. For proper electrical cleaning and performance keeping we recommend:
 - o Standard contacts: Minimum current = 20mA (20V)
 - o Gold plated contacts: Minimum current = 10mA (20V)
- **Operating frequency:** relays are components that can operate with a wide range of switching frequency. High frequency operation also allows a continuous cleaning effect by "sliding" (mechanical cleaning). In case of low frequency operation (for example few time a day), we advise:
 - o Use of contact with currents twice compared to those indicated.
 - o For currents lower than 10mA, use gold plated contacts and connect 2 contacts in parallel, in order to reduce the equivalent contact resistance
- **Pollution:** the presence of pollution can cause impurities on contact surface. Electric charges attract organic molecules and impurities that are deposited on the contact surface. Electrical and mechanical cleaning, respectively, burn and remove such impurities. In pollution presence, the minimum recommended currents must be respected. In extreme cases, provide double the cleaning current.

While a contact open high loads, impurities develop inside the relay due to the formation and interruption of the electric arc. These impurities are greater the higher the load and the more frequent the switching operation. These impurities could deposit on the adjacent contacts and alter the initial conductivity characteristics. If all contacts are used with similar loads, this is not a problem. Please, contact AMRA for further informations.

Condensation is possible inside the relay when energized and the outside ambient temperature is cold; this is quite normal and does not affect the operation of the relay. Plastic materials of relay do not possess hygroscopic properties.

Maintenance

No maintenance is required.

In case of normal relay wear (reaching the end of electrical or mechanical life), the relay cannot be restored and must be replaced.

To check the component, relay removal must be carried out with slight lateral movements. An "up and down" movement can cause terminals damage.

For RMBV15 / RMBV16 removal, please read the product instructions.

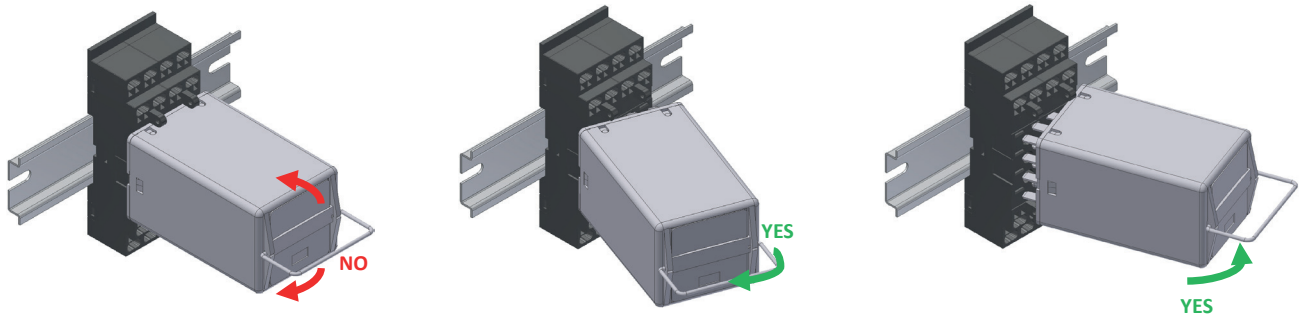

Often the malfunctions are caused by power supply with inverted polarity, by external events or by use with loads exceeding the contact performance.

In case of suspected malfunction, energize relay and observe if mechanical operation of contacts / relay mechanism is performed. Pay attention to the power supply polarity, if relay is equipped with polarized components (example: diode, led).

- In case of expected operation, clean the contacts (see paragraph "OPERATION") and check if the circuit load ranges within the contact performance. If necessary, replace with relays with gold contacts. Note: the electrical continuity of contacts must be checked with adequate current.
- If it does not work, we recommend to use a relay of the same model and configuration.

If an investigation by AMRA is required, pull-out the relay from the socket, don't remove the cap, avoid any other manipulation and contact us. You will be asked for the following data: environmental conditions, power supply, switching frequency, contact load, number of operations performed.

The fault can be described through the "TECHNICAL SUPPORT" section of the website www.amra-chauvin-arnoux.it.

In any case, the relay cannot be repaired by the user.

Storage

Storage conditions must guarantee the environmental conditions (temperature, humidity and pollution) required for the product conservation, in order to avoid deterioration.

The product must be stored in an environment sheltered from atmospheric agents and not polluted, with an ambient temperature between -40 and +85°C with max 75% RH. Humidity can reach peaks of 95%. In any case, there must be no condensation. Before use, please read carefully "OPERATION" section.